

short ar-111



ct 23 07 29 short ar-111
 aufbaustrahler 12v für
 boden, wand und decke
*surface mounted 12v spot-
 light for floors, walls and
 ceilings*

qr-lp 111 irc; max. 65w; g53;
 12v; ip 20; schutzklasse III

zubehör accessories

- ct 23 07 77 mini einbaupunkt 50 x 50
mini mounting spot 50 x 50
- ct 23 07 71 montageplatte 80 x 60
mounting plate 80 x 60
- ct 23 21 72 klemmbox 12v 80 x 60
clamp box 12v 80 x 60
- ct 23 07 73 montagepl. up-dose 104 x 80
mounting plate 104 x 80
- ct 23 07 78 doppel montageplatte 202 x 80
double mounting plate 202 x 80
- ct 23 07 87 vierfach montagepl. 450 x 80
four mounting plate 450 x 80

- ct 23 07 75 miniaufbautrafo 20–70w
mini transformer
- ct 23 07 79 doppel miniaufbautrafo
2 x 20–70w
double mini transformer
- ct 23 07 85 vierfach miniaufbautrafo
4 x 20–70w
four mini transformer
- ct 23 07 80 modul einbautrafo 20–70w
modul mini transformer

ct 23 33 63 maxi glare

leuchtmittel lamps

- ct 91 11 01 osram irc ar-111, 50w 8°
12v; 3300cd; 4000 h
- ct 91 11 02 osram irc ar-111, 50w 24°
12v; 5800cd; 4000 h

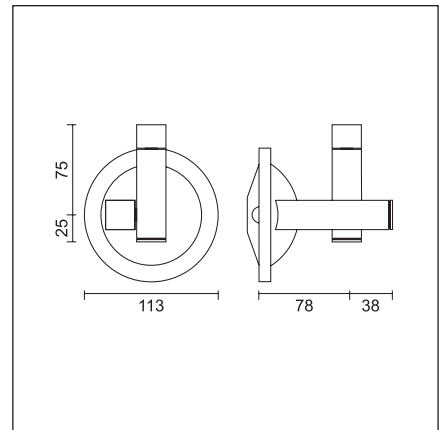

details zubehör siehe seite 24
see page 24 for details





short ar-111 + maxi glare
+ miniaufbautrafo

minimal compact zubehör / accessoires für / for ministar, ar-111 short, ar-111 long

entblendung

- ct 23 33 61 mini glare
entblendung für ct 23 07 21 /
23 / 33, mat black
- ct 23 33 63 maxi glare
entblendung für ct 23 07 25 /
27 / 29 / 37, mat black

zubehör für 12v versionen

- ct 23 07 77 mini einbaupunkt 50 x 50
zur direkten befestigung bei
gipskarton mit feder
(ausschnitt ø 40mm),
aluminium matt geschliffen,
eloxiert
- ct 23 07 71 montageplatte 80 x 60
zur befestigung mit schrauben,
aluminium matt geschliffen,
eloxiert
- ct 23 21 72 klemmbox
zur verwendung mit monta-
geplatte ct 23 07 71, bei auf-
putzverklebung 12v,
mid grey lackiert
- ct 23 07 73 montageplatte 104 x 80
zur montage auf 68mm up-
dose, aluminium matt ge-
schliffen, eloxiert
- ct 23 07 80 modul einbautrafo 20–70w
incl. montageplatte
ct 23 07 73, 68 mm hohlraum-
dose und einbautrafo 20–70w
- ct 23 07 78 double montageplatte 202 x 80
aluminium matt geschliffen,
eloxiert
- ct 23 07 87 vierfach montagepl. 450 x 80
aluminium matt geschliffen,
eloxiert
- ct 23 07 75 miniaufbautrafo 20–70w
aluminium matt geschliffen,
eloxiert, mid grey lackiert
- ct 23 07 79 doppel miniaufbautrafo
2 x 20–70w
aluminium matt geschliffen,
eloxiert, mid grey lackiert
- ct 23 07 85 vierfach miniaufbautrafo
4 x 20–70w
aluminium matt geschliffen,
eloxiert, mid grey lackiert

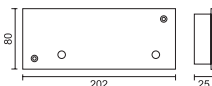
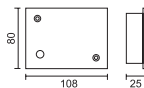
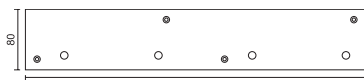
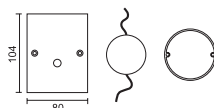
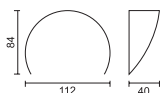
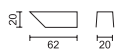

glare prevention

- ct 23 33 61 mini glare
glare prevention for ct 23 07 21
/ 23 / 33, mat black
- ct 23 33 63 maxi glare
glare prevention for ct 23 07 25
/ 27 / 29 / 37, mat black

accessories for 12v versions

- ct 23 07 77 mini einbaupunkt 50 x 50
for mounting directly onto
cavity ceilings with clip-
system (cut out ø 40 mm),
brushed aluminium, anodised
- ct 23 07 71 mounting plate 80 x 60
for screw-mounting, brushed
aluminium, anodised
- ct 23 21 72 clamp box
to be used with mounting
plate ct 23 07 71 for surface
mounting 12v, mid grey
lacquered
- ct 23 07 73 mounting plate 104 x 80
for mounting onto 68mm
flush box, brushed
aluminium, anodised
- ct 23 07 80 modul mini transformator 20–70w
incl. mounting plate ct 23 07 73,
68 mm flush box and mini
transformator 20–70w
- ct 23 07 78 2 x mounting plate 202 x 80
brushed aluminium, anodised
- ct 23 07 87 4 x mounting plate 450 x 80
brushed aluminium, anodised
- ct 23 07 75 mini transformator 20–70w
brushed aluminium, anodised,
mid grey lacquered
- ct 23 07 79 double mini transformator
2 x 20–70w
brushed aluminium, anodised,
mid grey lacquered
- ct 23 07 85 four mini transformator
4 x 20–70w
brushed aluminium, anodised,
mid grey lacquered

aufgrund der speziellen abdeckkappe der
minimal compact ar-111 versionen können nur
osram irc leuchtmittel verwendet werden.

due to the special cover cap of the minimal
compact ar-111 versions, they can only be used
with osram irc lamps.

